

	EQUIPAGGIAMENTI TECNICI LAVAGGIO	26.1040.00 26.1050.00 26.1055.00 GIUNTO GIREVOLE OTTONE MRO BRASS SWIVEL MRO		
				



SPECIFICHE TECNICHE SPECIFICATIONS

- PRESSIONE NOMINALE <i>RATED PRESSURE</i>	250 bar – 25 MPa (3650 psi)
- PRESSIONE CONSENTITA <i>PERMISSIBLE PRESSURE</i>	280 bar – 28 MPa (4050 psi)
- PORTATA MASSIMA <i>MAX FLOW RATE</i>	40 l/min (10.5 USG p.m.)
- TEMPERATURA MASSIMA DI LAVORO (UTILIZZO CONTINUO) <i>MAX WORKING TEMPERATURE (CONTINUOUS USE)</i>	90° C (194 °F)
- TEMPERATURA MASSIMA AMMESSA (SOLO PER BREVI PERIODI) <i>MAX PERMISSIBLE TEMPERATURE (FOR SHORT PERIODS ONLY)</i>	160° C (320 °F)
- NUMERO DI GIRI MAX. <i>MAX RPM</i>	30
- COPPIA ALLA PRESSIONE NOMINALE <i>TORQUE AT RATED PRESSURE</i>	~2 Nm (17.7 Lbs.in)
- MATERIALE <i>MATERIAL</i>	OTTONE (BRASS)
- GUARNIZIONI <i>SEALS</i>	OR IN FKM (VITON) O-RING SEALS IN FKM (VITON)

MISURE D'INGOMBRO OVERALL DIMENSIONS

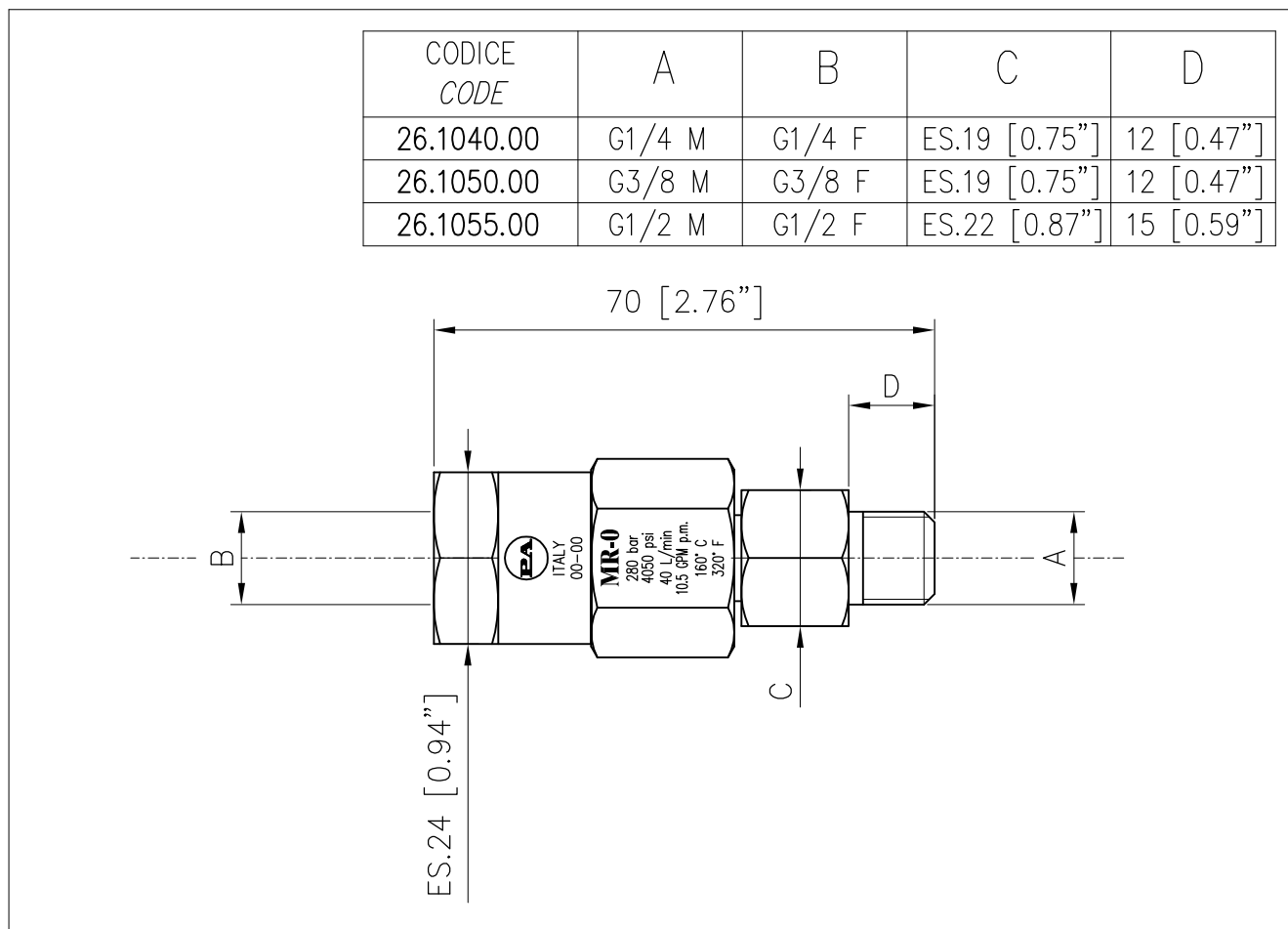

26.1040.00 MR-O Giunto gir. ott. G1/4 MF-sv.60°
26.1050.00 MR-O Giunto gir. ott. G3/8 MF con.60°

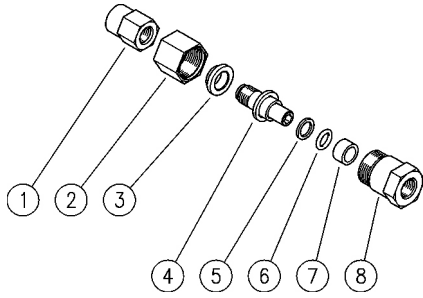

26.1055.00 MR-O Giunto gir. ott. G1/2 MF

Pos.	Codice	Descrizione	Q.tà	K1	K2	K3	K4	
1	26.1049.31	Attacco post. G 1/4 M sv.60° (1)	1					10
1	26.1101.31	Attacco post. M12x1,25F-G3/8M svas. ott. (2)	1					10
1	26.1057.31	Attacco post. M12x1,25F-G1/2M ott. (3)	1					10
2	26.1042.31	Ghiera M22x1 ott.	1					10
3	26.1045.84	Boccola 12x20x6 mm Plast.	1	•	•			5
4	26.1041.31	Perno M12x1,25 ott.	1					10
5	10.4010.01	An. anties. a. 10,2x13,9x1,2 mm	1	•	•			50
6	10.3109.95	An.OR 2,4x9,3 mm Vi 70	1	•	•			25
7	26.1046.84	Boccola 10x14x7 mm Plast.	1	•	•			5
8	26.1044.31	Attacco ant. M22x1M-G1/4F ott. (1)	1					10
8	26.1051.31	Attacco ant. M22x1M-G3/8F ott. (2)	1					10
8	26.1056.31	Attacco ant. M22x1M-G1/2F ott. (3)	1					10

Kit	Codice	Descrizione	
K1	26.1053.24	Kit ric. MR 4x1pz.	1
K2	26.1048.24	Kit ric. MR 4x10pz.	1

(1) 26.1040.00 (2) 26.1050.00 (3) 26.1055.00

26.1040.00 MR-O Swivel, brass 1/4 MF Bsp

26.1050.00 MR-O Swivel, brass 3/8 MF Bsp 60° con.

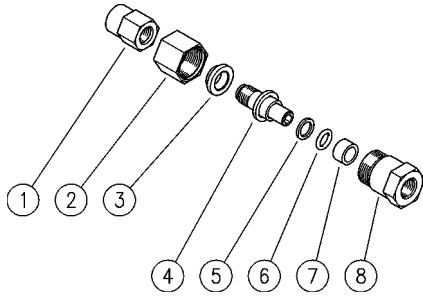

26.1055.00 MR-O Swivel, brass 1/2 MF Bsp

Pos.	P/N	Description	Q.ty	K1	K2	K3	K4	
1	26.1049.31	1/4 Bsp M back fitting -60° cone (1)	1					10
1	26.1101.31	Back cpl.,M12x1,25F-3/8M Bsp c/sunk brs (2)	1					10
1	26.1057.31	Back coupling, M12x1,25F-1/2M Bsp brs (3)	1					10
2	26.1042.31	Ring nut, M22x1 brass	1					10
3	26.1045.84	Bushing, 12x20x6 mm Plast.	1	•	•			5
4	26.1041.31	Pin, M12x1,25 brass	1					10
5	10.4010.01	Back-up ring,10,2x13,9x1,2mm	1	•	•			50
6	10.3109.95	O-ring, 2,4x9,3 mm Vi 70	1	•	•			25
7	26.1046.84	Bushing, 10x14x7 mm Plast.	1	•	•			5
8	26.1044.31	Front coupling, M22x1M-1/4F Bsp brass (1)	1					10
8	26.1051.31	Front coupling, M22x1M-3/8F Bsp brass (2)	1					10
8	26.1056.31	Front coupling, M22x1M-1/2F Bsp brass (3)	1					10

Kit	P/N	Description	
K1	26.1053.24	Spares kit -MR, 4x1pcs.	1
K2	26.1048.24	Spares kit -MR, 4x10pcs.	1

(1) 26.1040.00 (2) 26.1050.00 (3) 26.1055.00



P.A. S.p.A.

Via Milano, 13
42048 Rubiera, Reggio Emilia - Italy

Tel +39.0522.623611
Fax +39.0522.629600

info@pa-etl.it

www.pa-etl.it



COMPANY WITH QUALITY MANAGEMENT
SYSTEM CERTIFIED BY DNV
= ISO 9001 =